

Product name	Firestopit Sealant
Product Code	N/A
Revision Date	25/05/09
Revision number	01
Ref	IM SEALANT



Figure 1.

Sound practice exists for the prevention of failure and these should be carefully considered by designers, prior to writing specifications for sealants and their application:

1. Consider the movement of the joint to be sealed. This should include thermal, wind pressures, settlement and differential movement of components.

2. Consider the characteristics of the substrates as they affect the choice of sealant, i.e. how the surface finish may be affected by sealant compounds and the possibility of discolouration due to oil migration or staining.

3. Consider the location and environment of the joint to be sealed. Exposure to temperature extremes, ultra violet light, radiation, chemical attack, standing water and vibration.

4. Consider the characteristics of all available sealants for performance capabilities, hardness after weathering, movement capabilities in both extension and compression, adhesion properties and chemical resistance.

5. Adequate space and accessibility should be provided for applying and tooling the sealant. A suitable backing material to control the sealant depth should be used. Bond breaker materials should also be used to prevent three sided adhesion which causes sealant failure - see Figure 2.

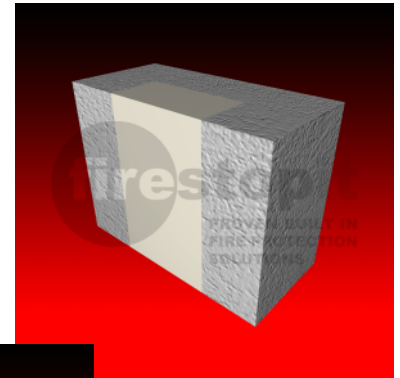

Figure 2.

Three sided adhesion gives cohesive failure of sealant.

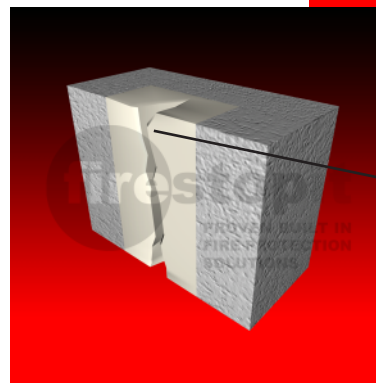

Figure 3.

Polyethylene bond breaker tape

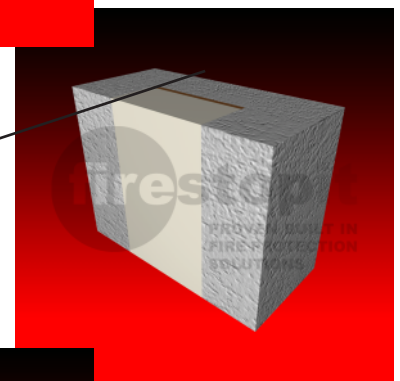
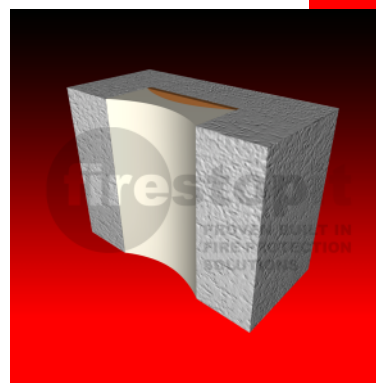

Figure 4.

Use of bond breaker tape gives two sided adhesion and allows the sealant to stretch freely with the joint.



**STRUCTURAL MOVEMENT
IN SEALANTS**

In structural sealing situations the joint dimensions are critical. In Figure 5 one can see the stresses encountered due to structural movement. The sealants cross sectional shape changes but the volume remains the constant. Therefore when joints are designed it is essential to provide a suitable width-to-depth ratio which will enable the sealant to withstand the maximum strain anticipated due to the structural movement of the joint.

Figure 5.

Maximum Strain

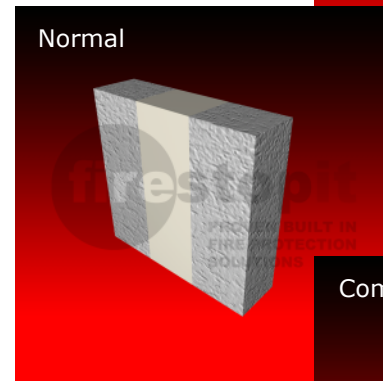
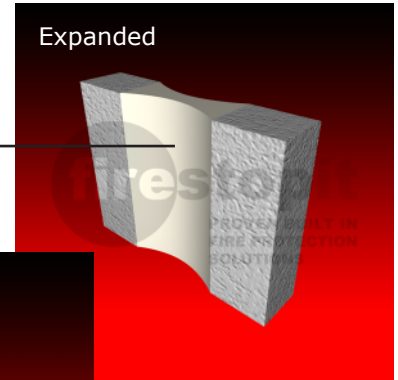
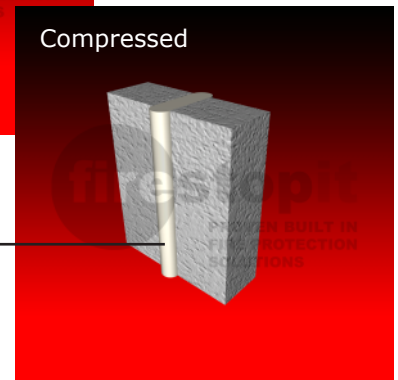

Figure 6.

Figure 7.

Maximum Strain



DIMENSIONAL REQUIREMENTS

1. The joint depth should be such as to provide a minimum sealant depth of 6mm
2. In concrete or masonry joints where structure movement is expected the sealant depth should be 12-18mm dependent on the joint width.
3. If the joint width is less than 12mm, the depth of sealant should be not less than one half of the width and not greater than the width. (The minimum depth of 6mm still applies) N.B. If the joint width is 6mm then the joint depth is 6mm. This is the minimum joint size.
4. For joints between 12mm and 50mm the sealant depth should be one half of the joint width.

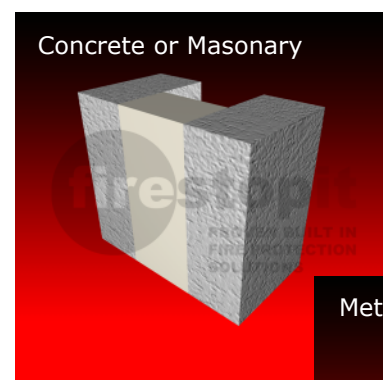

Figure 8.



Figure 9.

ie TYPICAL EXAMPLE OF INSTALLATIONS

The following is a guide for those responsible for writing specifications and installation schedules.

1. Ensure that all surfaces are dry and free from contamination, dust, grit, frost, moisture, etc.

2. Where applicable i.e. To reduce the joint depth to an acceptable level (usually $D = W / 2$ with a minimum depth of 6mm) a joint backer rod is used. The backing material is tamped into position to give the required joint depth.

N.B. An oversized backing rod should be used to ensure that it remains in position, i.e., a 12mm wide joint requires a 15mm diameter backing rod.

3. The primer, if required, should be applied to the two opposite vertical faces taking care not to prime the backing material. (This will eliminate the possibility of failure due to three sided adhesion). The primer should be applied according to manufacturers instructions.

4. To obtain a neat finish, masking tape should be applied to the face edgings for protection during application of the sealant.

Figure 10.

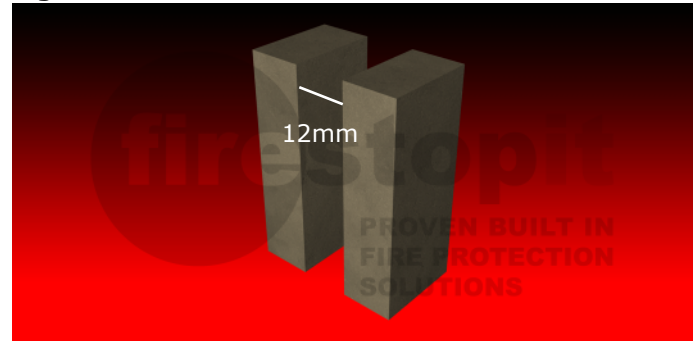

Figure 11.

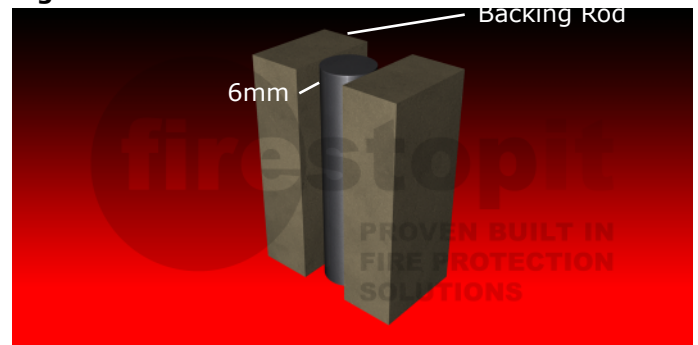

Figure 12.

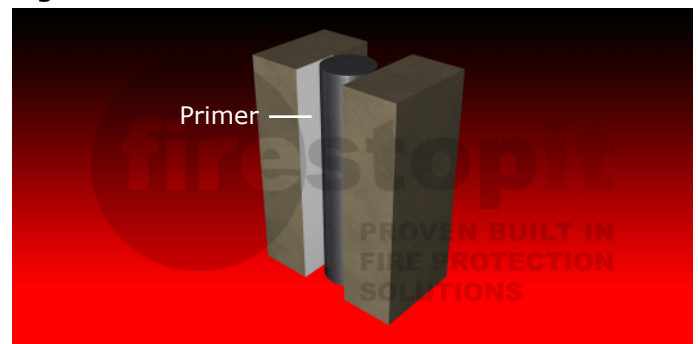
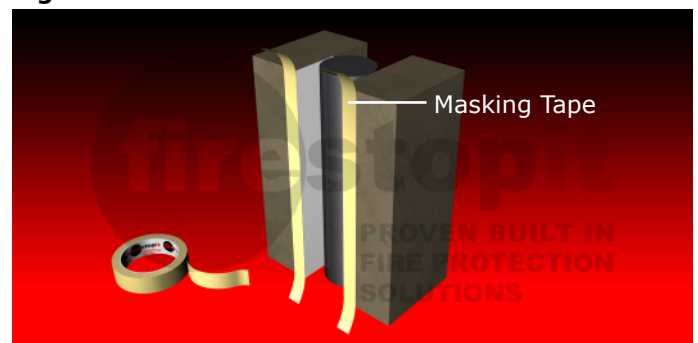

Figure 13.



5. If using a two-part sealant, the sealant should be mixed according to the manufacturers instructions and then placed in a cartridge for application.

The sealant should be gunned firmly into the joint ensuring that it is in full contact with the sides of the joint. Failure to carry this out may result in poor adhesion of the sealant and ultimate failure of the joint.

6. Tooling of the sealant may be necessary to achieve an acceptable appearance. This is accomplished by drawing a flat tool over the surface of the sealant to produce a smooth neat finish. Tooling also compresses the sealant into the joint enhancing the adhesion to the joint sides.

7. Once a smooth acceptable appearance has been achieved, remove the masking tape by drawing it across the joint. This will ensure that any 'tails' of sealant fall into the joint, ensuring that there are no unsightly marks on the substrate.

The type of sealant required for any given application, is dependent on the amount of movement expected from the joint.

Figure 14.

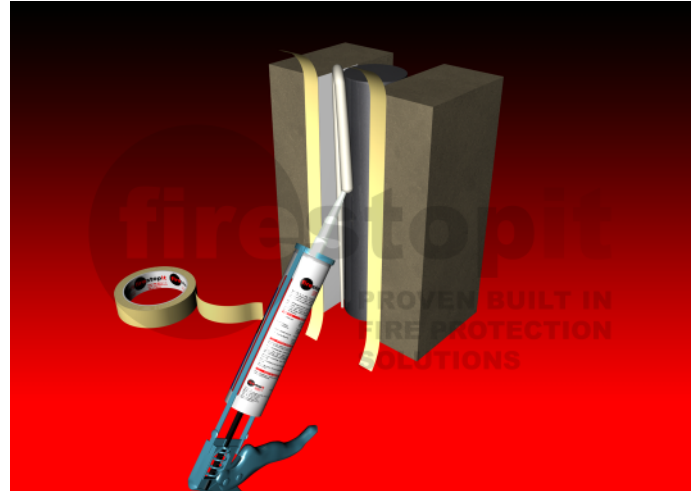

Figure 15.

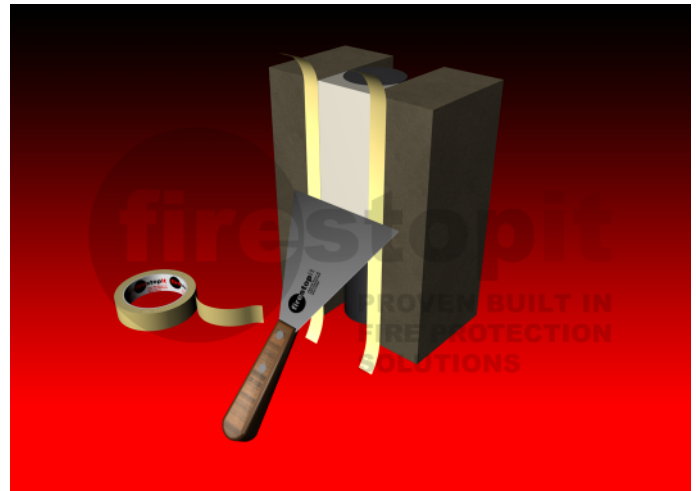
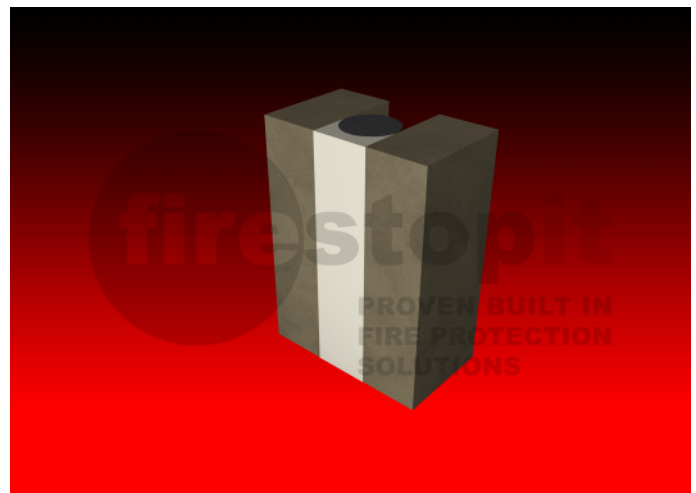

Figure 16.



Floor & Wall Joint Size Width x Depth	Backing	Linear Metres per Cartridge
6mm x 10mm	PE Open Cell Foam	5.16
10mm x 10mm	PE Open Cell Foam	3.1
15mm x 10mm	PE Open Cell Foam	2.07
20mm x 10mm	PE Open Cell Foam	1.55
25mm x 15mm	PE Open Cell Foam	0.83
30mm x 15mm	PE Open Cell Foam	0.69
35mm x 20mm	PE Open Cell Foam	0.44
40mm x 20mm	PE Open Cell Foam	0.39
45mm x 25mm	PE Open Cell Foam	0.28
50mm x 25mm	PE Open Cell Foam	0.25
5mm x 15mm	PE Open Cell Foam	4.13
10mm x 15mm	PE Open Cell Foam	2.07
15mm x 15mm	PE Open Cell Foam	1.38
20mm x 15mm	PE Open Cell Foam	1.03
25mm x 15mm	PE Open Cell Foam	0.83
30mm x 15mm	PE Open Cell Foam	0.69